

**canfield connector**  
8510 Foxwood Court  
Youngstown, Ohio 44514  
(330) 758-8299 Fax: (330) 758-8912  
www.canfieldconnector.com

## SERIES 8WS (WORLDSWITCH)

## REED & ELECTRONIC SENSORS FOR PNEUMATIC CYLINDERS WITH 12MM DOVETAILED

### General Description

The Canfield Connector Series 8WS reed and electronic magnet sensors are rugged yet compact switches used to sense position on pneumatic actuators equipped with a magnetic piston and 12mm dovetail groove. The switch can be slipped in and tightened from anywhere along the groove that is fabricated into the cylinder wall or clamping system. The switch features a die cast holder which clamps to the cylinder groove while the electronics are fully encapsulated and resistance to environment. These sensors offer a wide voltage range from 0-120 V AC/DC 50/60Hz and have a up to a 500 mA switching current rating. The switch has a high intensity indicator light which indicates power to the switch and load. The switch comes standard with 9 ft. PVC or 8mm quick connect male pigtail.

### Dimensional Data

ALL DIMENSIONS ARE IN MILLIMETERS UNLESS OTHERWISE NOTED

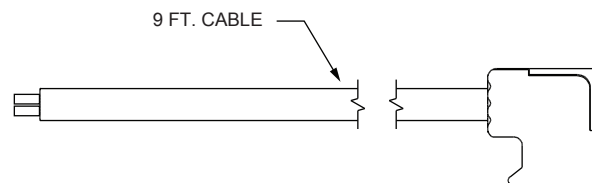
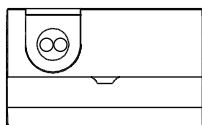
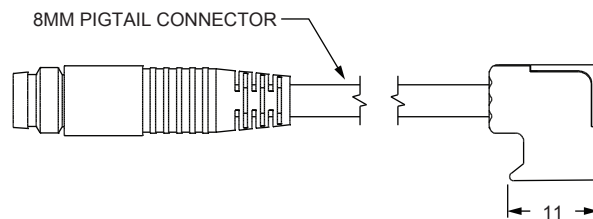
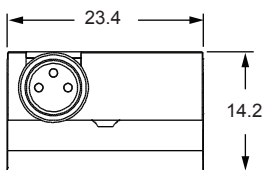
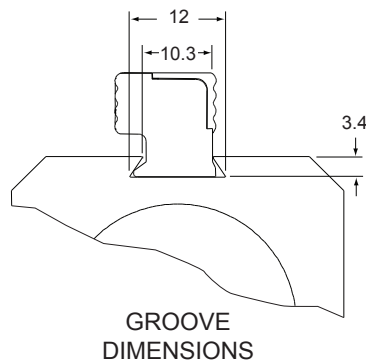
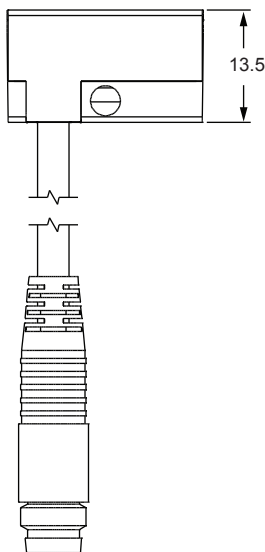

## Technical Data

- Temperature Range: Operational from -20° to +80°C
- Shock: Operational up to 30G (11 ms.) reeds only. Not applicable for electronic.
- Vibration: Operational up to 20G (10 - 55 Hz) reeds only. Not applicable for electronic.
- Sensitivity and orientation: 85 gauss parallel (standard minimum required for proper operation, as measured on sensor surface. Size of sensing area depends on size and strength of magnet and thickness of cylinder wall.
- Most versions designed to meet NEMA 6/IP67 specifications

## Features

- Robust design
- Metal housing
- Simple installation
- Reverse polarity
- Quick connect designs available
- Wide voltage range
- High current capacity
- Over voltage protection
- Indicator light can be seen from all angles



Consult factory for available versions listed by Canadian Standards Association for use with certified electrical equipment.

## Installation

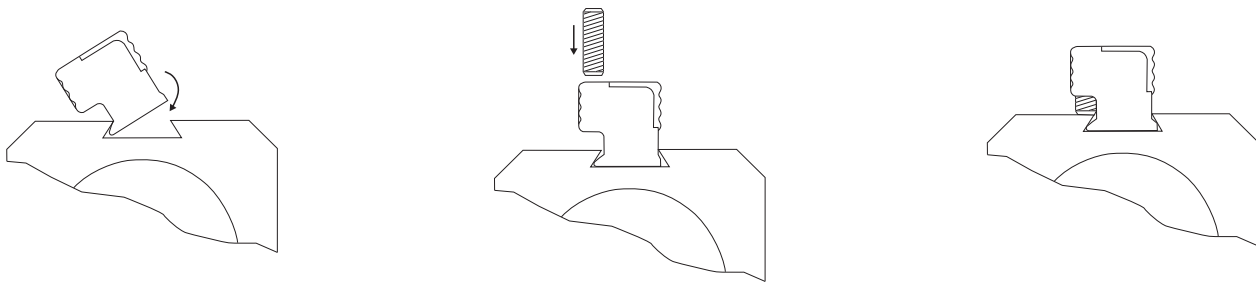

## Ordering Information

8WS10-000-□□□

### Connection Options

- 0 - 9 ft PVC cable
- 1 - 8mm quick connect male pigtail\*

\*Mates with cordset shown at right.

### Mating Cordsets 8mm female molded locking connectors

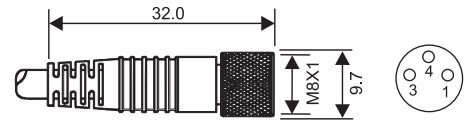

(for sensor types 01, 02, 04, 31, 32)

### Order part number

Brown = Pin 1  
Blue = Pin 3  
Black = Pin 4

RC08S-F0M030120 (2m length)  
RC08S-F0M030150 (5m length)

| Type | Description                                | Function            | Switching Voltage | Switching Current                  | Switching Power | Voltage Drop | ** Magnetic Sensitivity |
|------|--|---------------------|-------------------|------------------------------------|-----------------|--------------|-------------------------|
| 01   | Reed Switch                                | Normally Open       | 0 - 120V AC/DC    | 0.5 Amps Max.                      | 10 watts Max.   | 0 Volts      | 85 Ga.                  |
| 02   | Reed Switch & LED                          | SPST Normally Open  | 5 - 120V AC/DC    | 0.025 Amps Max.<br>0.001 Amps Min. | 3 watts Max.    | 6.0 Volts    | 85 Ga.                  |
| 04   | Reed Switch, LED & MOV                     | SPST Normally Open  | 5 - 120V AC/DC    | 0.5 Amps Max.<br>0.005 Amps Min.   | 10 watts Max.   | 3.0 Volts    | 85 Ga.                  |
| 31   | Electronic for Reed Magnet, LED & Sourcing | Normally Open (PNP) | 6 - 24 VDC        | 0.3 Amps Max.                      | 7.2 watts Max.  | .5 Volts     | 85 Ga.                  |
| 32   | Electronic for Reed Magnet, LED & Sinking  | Normally Open (NPN) | 6 - 24 VDC        | 0.3 Amps Max.                      | 7.2 watts Max.  | .5 Volts     | 85 Ga.                  |

\*\*Minimum gauss rating required for proper operation; as measured 4.5 above sensing surface. Size of sensing area depends upon size and strength of magnet and thickness of cylinder wall.

### Ordering Example:

8WS10-000-002

9 ft. PVC cable, reed switch for PLC with LED, SPST normally open, 5 - 120V AC/DC